

# **Measurement Control Unit**

---

## **ZX400**

### **USER MANUAL**

**Sanmenxia ZhongyuanJingmi Co.,Ltd**

In order to use the instrument safely, please follow the following instructions

### [DANGER]

- Hazardous voltage can cause injury or death.
- Do NOT take out the covers unless there is qualified maintenance personnel.
- Please turn off the power switch and disconnect the power supply cable before taking out covers.

### [WARNINGS]

- Hydraulic cylinder can cause injury. when used, driving gage head forward (downward) or backward (upward) can cause injury. Please make sure the connected machine is not operating before touching the hydraulic cylinder.
- Driven contacts of gage head can cause injury. Please make sure the connected machine is not operating before touching the gage head contacts.

### [CAUTIONS]

- Be sure not to operate this system when the gagging unit and/or control unit are in failure (such as when the READY signal has gone off).
- Heavy load or strong force can deform the covers of control unit.
- Do not stand or step on the cover of the unit.
- For the sake of safety, the grounding wire of the power supply and all parts must be grounded, and the outer shell of the controller is located at the screw above



the output line socket.

- Operation conditions must be:

1. Operation temperature                      0~40 °C
2. Humidity                                      Less than 90%
3. Vibration                                      Least possible ( less than 0.1G)

- Cleaning of the front panel:

1. The front panel is made from an acrylic resin pre-processed for non-glaring.
2. When the panel has smeared, dip a piece of soft cloth into liquid of neutral detergent or anti-static agent, and wipe the panel with the cloth lightly.
3. Please do NOT use organic solvents such as alcohol to clean the device.

## **[ABOUT CARRYING ABROAD]**

Due to the various local rules, please inform us before taking this device out of China. Our company will not be responsible for any overseas accident if there is no declaration.

## **[WARRANTY DESCRIPTION]**

1. This product warranty service is only valid under normal use.
2. Non product quality issues and malfunctions caused by abnormal use are not covered by warranty.

For example, malfunctions caused by the following circumstances, including but not limited to, are not covered by warranty:

- (1) The display panel was shattered due to external impact.
- (2) The user opened this product without authorization, which caused moisture and liquid ingress.
- (3) The user's wiring error or abnormal power connection caused this product to malfunction.

# CONTENTS

<b>1、 Introduction</b>	<b>1</b>
<b>2、 Features</b>	<b>2</b>
<b>3、 Extension Function</b>	<b>3</b>
<b>4、 Interface</b>	<b>4</b>
<b>4.1、 Measuring Interface</b>	<b>5</b>
<b>4.2、 Setting Interface</b>	<b>6</b>
<b>4.3、 Adjustment Interface</b>	<b>9</b>
<b>5、 I/O Interface And Connection</b>	<b>10</b>
<b>6、 WSD-100A External Retraction Device</b>	<b>13</b>
<b>7、 Method Of Use</b>	<b>14</b>

# 1、 Introduction

Z400 controller is based on the latest digital signal processing system, using the latest control technology designed for grinding machine processing on-line monitoring and control of the instrument.

This controller will be processed or after the size of the workpiece, with electric sensor for measurement, if the use of air momentum meter for measurement, it needs to be measured through the pneumatic probe and AE converter. The measurement results are displayed on the LCD touch screen, and the control signal is sent to the machine at the preset size. It has better man-machine effect and more intuitive measurement status display. Easy to operate, display more diversified.

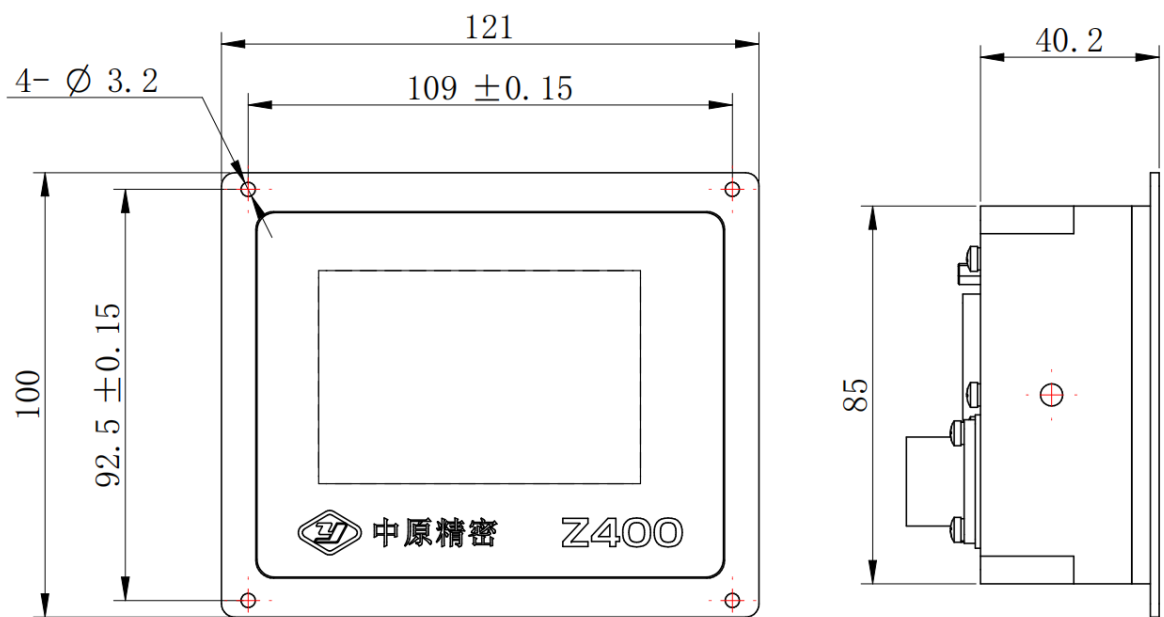

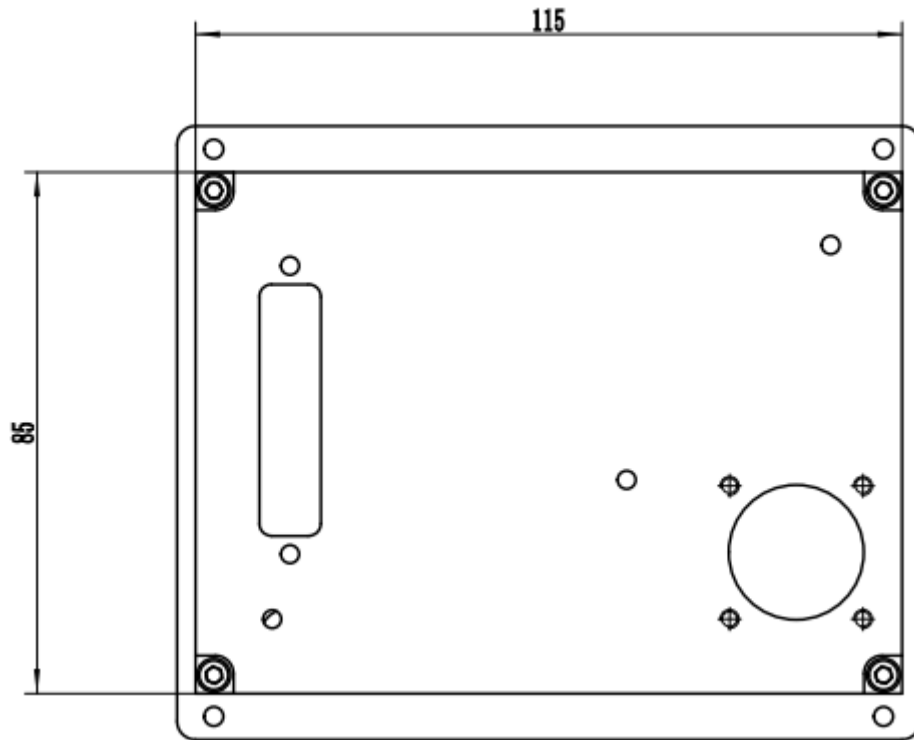

## 2、 Features

- 1) Intelligent control: All kinds of calculation and correction can be carried out within the standard range, or the machining size correction can be completed automatically under the control of the machine tool. In the process or after the processing of the measurement process, display a variety of measurement results and judge the status of the point, while sending a signal to control the movement of the machine.
- 2) Convenient and compact: Using 3.5-inch TFT touch screen LCD display, embedded installation, low power design. Saving installation space, energy saving and environmental protection.
- 3) Good human interface: The display interface is more intuitive and clear, the display content is more rich and comprehensive, and the operation is simpler and faster.

- 4) Good compatibility: In addition to the improvement of control, display, operation, reliability and signal acquisition accuracy, the new meter is easy to install and maintain.
- 5) Optimized design, the whole machine can meet the industrial interference test.

### **3、 Extension Function:**

- 1) External compensation: The measured data are compensated according to external input signals.
- 2) Memory selection: In order to measure the discontinuous surface can set memory function, such as maximum memory.
- 3) 485 output.
- 4) Standard dual-channel sensor input.

## 4、Interface

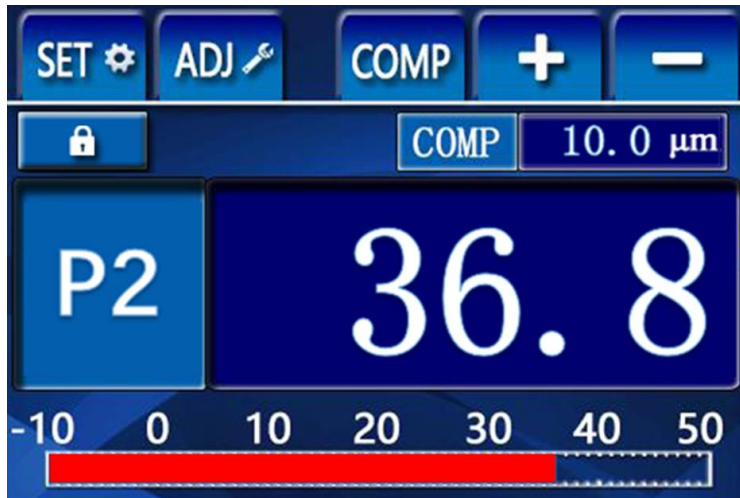

### Instructions:

ZX400 type active grinding measuring instrument is divided into three function Windows, measuring, setting and adjusting. The system defaults into the measurement module.

After power-on, the measurement interface displays  as locked, and at this time, click the other buttons

Reaction, you need to click this button again to change to , and then it is in the unlocked state before normal operation.

Click the button  to enter the setting window.

Click the button  to enter the adjustment window.

Click the button  to manually enter the compensation value.

Click the button : Compensation + .

Click the button : Compensation - .



## 4.1 Measuring Interface

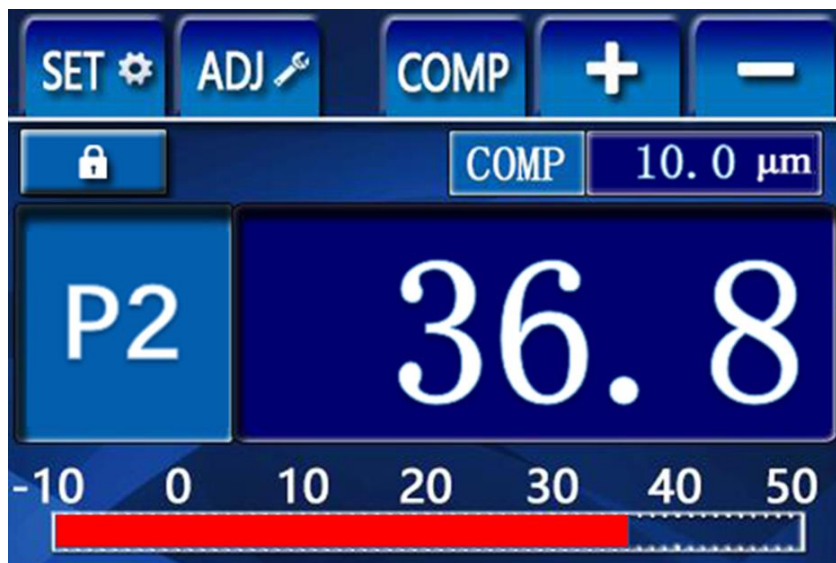

Window functions: The measured value of the measuring item is displayed, adjusted and displayed in digital form.

Instruction:

**36.8**: Displays the measured value of the measured item.

**P2**: Display signal points.

**COMP 10.0 μm**: Display compensation value.

## 4.2 Setting Interface



If you need to change the setting parameters, click the number section, and the keyboard pops up for setting.

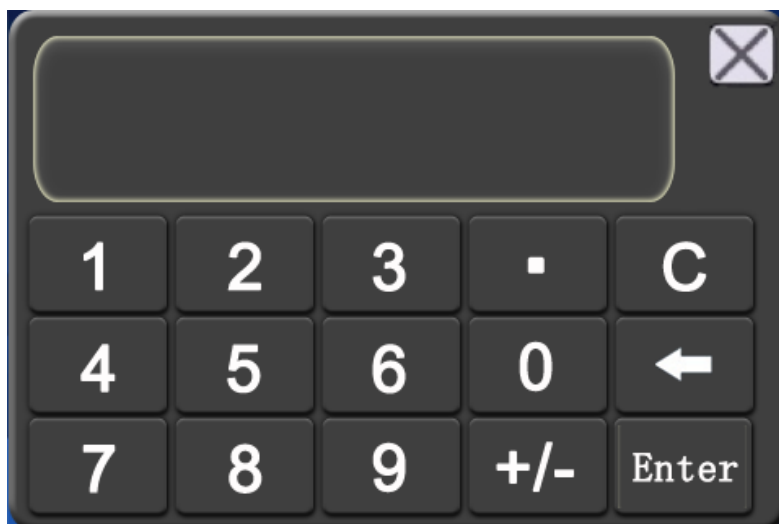

Instruction:

P1 Signal points of rough grinding ;

P2 Signal points of fine grinding;

P3 Light grinding signal points;

P4 The signal point of retreating knife;

**Signal point setting value: P1>P2>P3>P4;**

SCUT The reverse cut value;

M Measurement expression: Can choose G1 ,G2 ,G1+G2 ,G1-G2;

S Filter way: Can choose 0, 1, 2, 3, 4, 5. (This option is a special function and is only available when the user makes a special order.)

**※Special function page (valid only for special functions)**

1、Click "" in the setting interface to enter:

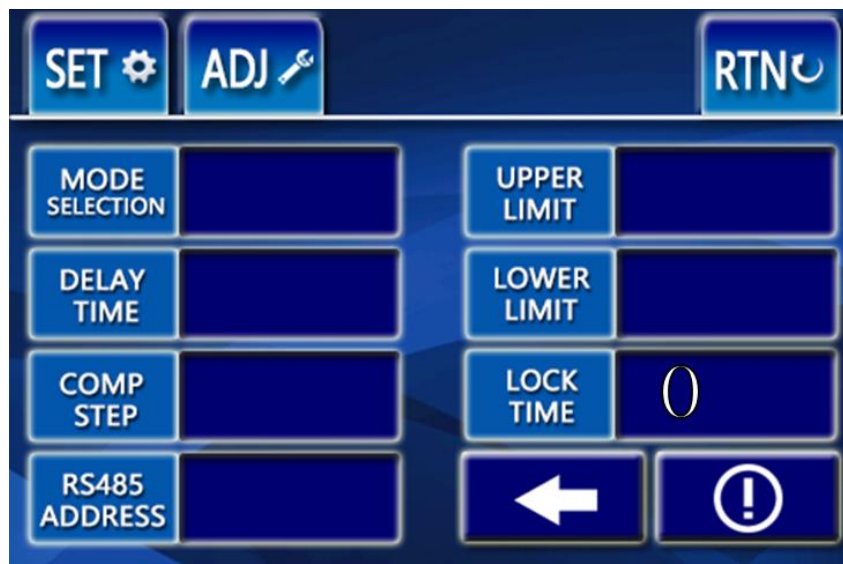

2、**P5 Alarm signal**

On the second page of setting, enter “UPPER LIMIT” and “LOWER LIMIT” respectively.

For example, if it is set to - 40~100, the "P5" alarm signal will be given when the measured display value is greater than 100 or less than - 40.

3、**Judgment start function**

The “MODE SELECTION” is set to "decision", and the “DELAY TIME” is set to the delay time of the output signal sent by the controller to the machine tool after the machine tool gives the decision start signal (the delay time can be set to "1~6").

4、**Screen lock time is the delay time of automatic screen lock after unlocking**

Set to "0", that is, turn off the automatic screen locking function. You need to manually click the lock button on the measurement interface to lock it.

Set to "5", that is, after 5 seconds of keyless operation, it will automatically return to the measurement interface lock screen. (The screen locking time can be set to "5~20")

## 5、 COMP STEP

Set to 1, that is, adjust the "+" and "-" variation of the measurement interface to 1  $\mu$  m.

You can switch to "1", "0.5" and "2".

## 6、 Language Selection

Click  to enter the language selection interface. Switch between Chinese and English.

### 4.3 Adjustment Interface



Instruction:

**DISPLAY DATA**

: the value of the probe after processing;

**ZEROED DATA**

: the compensation value of the probe by the system after resetting;

**CAL**

: the probe amplification ratio can be set through the pop-up keyboard; (The factory has been set, the standard value is 1, the user does not need to adjust. Adjustment is required only when changing the length of measuring device or rod.)

**AUTO ZERO**

: press once to reset the displayed value, press again to restore the original value;

The upper and lower measuring rods of the double-channel device are G2 and G1 respectively.

## 5、 I/O Interface And Connection

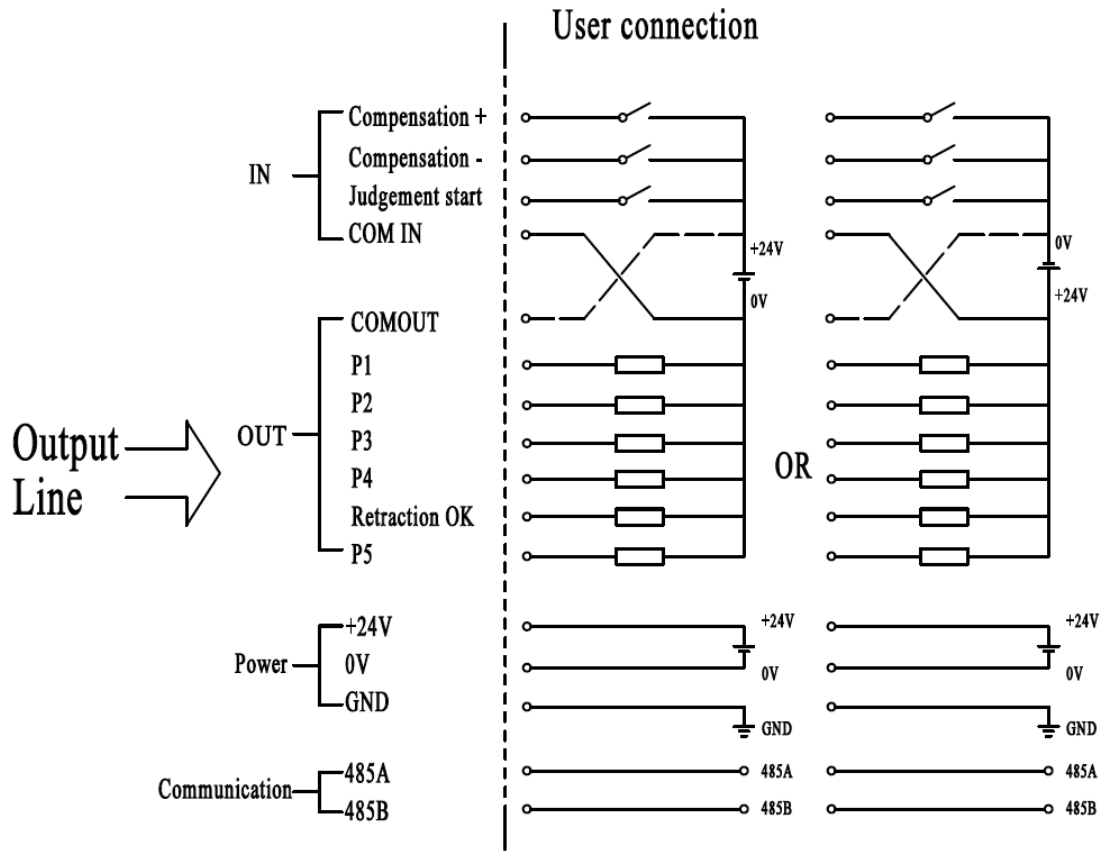

### I/O parameters:

Power supply: 24VDC  $\pm$  20% (> 10W) 24V and 0V are respectively connected to the red line and black line of the output line

Output signal: relay 220V 5A

Input signal: optocoupler 24V 3mA

Ground wire: grey wire connects machine tool ground wire

**※ The output wire wiring list shall be selected according to the number of output wire cores.**

**Wiring list of 8-core/19-core output line (black cable)**

Number	Color	I/O	Single item
1	Green	OUT1	P1
2	Yellow	OUT2	P2
3	Pink	OUT3	P3
4	Blue	OUT4	P4
5	Brown	OUT5	Retraction OK
6	Blue/Black	OUT6	P5
7	Green/Black	OUT7	*
8	Red/White	IN1	*
9	White	COMOUT	COMOUT --24V or 0V
10	Yellow/Blue	IN2	Compensation +
11	Blue/White	IN3	Compensation -
12	Green/White	IN4	Judgement Start
13	Purple	COMIN	COMIN --0V or 24V
14	Red/Black	485B	485B
15	Yellow/Black	485A	485A
16	Gray	GND	GND
17	Purple/white	IN0	*
18	Black	24V-0	Power Supply--0V
19	Red	24V	Power Supply--24V

## 25-core output line (white cable) wiring list

Number	Color	I/O	Single item
1	Orange	OUT1	P1
2	Yellow	OUT2	P2
3	Pink	OUT3	P3
4	Blue	OUT4	P4
5	Brown	OUT5	Retraction OK
6	Green	OUT6	P5
7	Light green	OUT7	*
8	Red/White	IN1	*
9	White	COMOUT	COMOUT --24V or 0V
10	Orange / White	IN2	Compensation +
11	Blue / White	IN3	Compensation -
12	Purple / White	IN4	Judgement Start
13	Purple	COMIN	COMIN --0V or 24V
14	Red/Black	485B	485B
15	Orange/Black	485A	485A
16	Gray	GND	GND
17			
18	Yellow/Black	5V	*
19	Black/White	*	*
20	Green/White	*	*
21	Green/Black	IN0	*
22	Black	24V-0	Power Supply--0V
23			
24	Red	24V	Power Supply--24V
25			







## 6、WSD-100A External Retraction Device

<b>WSD-100A external retraction device</b>	
Terminal number	ZHD-1140BC (ZHS-173DC)
1	AC 220V
2	AC 0V
3	Red line
4	Yellow line
5	Black line COM
6	Retraction input (switch signal)
7	Retraction input (switch signal) COM



## 7、 Method Of Use



### 7.1 Adjustment method for standard double rod single channel sensor (ZHD-1070BC\1090BC\1080BC)

Enter the boot screen and press the button above the screen  or  set the display value after compensation to 0.

Adjust the upper and lower contacts away from the measuring surface. Click , the system enters the adjustment window, the interface displays G1, records the size of the display value, adjusts the lower contact, makes the display value change to about half of the initial value, locks the lower contact, and then continues to adjust the upper contact, Change the display value to about 0 (within  $\pm 30$ ), lock the upper contact. At this point, click , the display value changes to 0, the probe compensation value enters the resetting, and the adjustment is over. Click , enter the measurement interface.

### 7.2 Standard Single Channel Sensor Adjustment Method (ZHS series)



Enter the boot screen and press the button below the screen  or  set the display value after compensation to 0.

Adjust the contact away from the measuring surface. Click , the system enters the adjustment window, the interface displays G1, records the display value, adjusts the contact to make the display value change to about 0 (the value is within  $\pm 30$ ), and locks the contact. At this point, click , the display value becomes 0, the probe compensation

value enters the resetting value, and the adjustment ends. Click , enter the measurement interface.

### 7.3 Standard dual-channel sensor adjustment method (ZHD、ZHF series, except ZHD-1070BC\1090BC\1080BC)

Enter the boot screen and press the button below the screen

 or  set the display value after compensation to 0.

Adjust the contact away from the measuring surface. Click  the system enters the adjustment window, the interface displays G1, records the display value, adjusts the lower contact to make the display value change to about 0 (the value is within  $\pm 30$ ), and locks the contact. At this

point, click , the display value becomes 0, the probe compensation value enters the resetting value, and the lower probe adjustment ends.



Display G2 on the interface, record the size of the display value, adjust the upper contact to make the display value change to about 0 (within  $\pm 30$ ),

and lock the upper contact. At this point, click , the display value becomes 0, the probe compensation value enters the resetting value, and



the adjustment ends. Click , enter the measurement interface.

### 7.4 Adjustment method for standard pneumatic sensors (ZHS-AH series)

Enter the boot screen and press the button below the screen

 or  set the display value after compensation to 0. Click , the system enters the adjustment window, the interface displays G1, records the size of the display value, adjusts the throttle valve of the sensor, makes



the display value change to about 0 (the value is within  $\pm 30$ ), and locks.

At this point, click , the display value changes to 0, the probe compensation value enters the resetting value, and the sensor adjustment ends. Click , enter the measurement interface.

## 7.5 Multiplier adjustment method

During the use of the meter, the ratio should be adjusted when changing the length of the measuring device or measuring rod.

Adjust the upper and lower contact away from the measuring surface.

Click , the system enters the adjustment window, and the interface displays G1. Adjust the lower contact so that the display value is about 0 (value within  $\pm 30$ ). Click , the display value is 0. Insert a 0.05mm feeler between the contact and the measuring surface and record the display value. Click , Jump out of the keyboard, according to the actual value and display value of the multiple relationship, directly input the corresponding value. Repeat the process three times. The adjustment ends when the displayed value is consistent with the actual value of the feeler. G2 is tuned the same as G1. Factory default setting is 1.00 (except ZHS-AH series).

**The meter has been accurately adjusted according to the standard when leaving the factory. There is no need to adjust the scaling rate during normal use.**

**V1.7 202401**



**Sanmenxia ZhongyuanJingmi Co.,Ltd**

**Address: East Section of Weiliu Road, Sanmenxia Industrial Park, Henan  
Province, China**

**Tel: 0398-2751818 Fax: 0398-2751819**

**Postcode: 472000**

**<http://www.zyjm.com>**